

Electronic timer CT-AHD.22

OFF-delayed with 2 c/o contacts

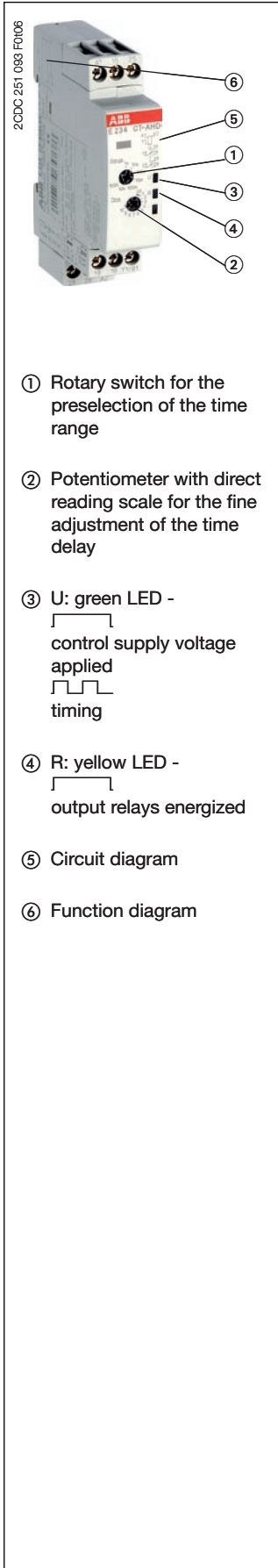



Data sheet



Features

- Rated control supply voltage 24-48 V DC, 24-240 V AC
- Single-function timer OFF-delay
- 7 time ranges (0.05 s - 100 h) in one device
- 2 c/o contacts (250 V / 5 A)
- Control input: voltage-related triggering, polarized, capable of switching a parallel load
- 2 LEDs for status indication
- Width of only 17.5 mm
- Light-grey enclosure in RAL 7035

Approvals

	UL 508, CAN/CSA C22.2 No.14	
	GOST	
	CB scheme	pending
	CCC	pending

Marks

	CE	
	C-Tick	pending

Order data

Type	Rated control supply voltage	Time range	Output	Control input	Order code
CT-AHD.22	24-48 V DC, 24-240 V AC	0.05 s - 100 h	2 c/o contacts	voltage-related triggering	1SVR 500 110 R0100

Application

With their structural form and their width of 17.5 mm only, the CT-D range timers are ideally suited for installation in distribution cabinets.

Operating mode

The CT-AHD.22 with 2 c/o contacts and offers 7 time ranges, from 0.05 s to 100 h. The time delay range is rotary switch selectable on the front of the unit. The fine adjustment of the time delay is made via an internal potentiometer, with a direct reading scale, on the front of the unit.

Electronic timer CT-AHD.22

OFF-delayed with 2 c/o contacts

Data sheet

Function diagram(s)

■ OFF-delay with auxiliary voltage

This function requires continuous control supply voltage for timing.

If control input **A1-Y1/B1** is closed, the output relay energizes immediately. If control input **A1-Y1/B1** is opened, the time delay starts. The green LED flashes during timing. When the selected time delay is complete, the output relay de-energizes and the flashing green LED turns steady.

If control input **A1-Y1/B1** recloses before the time delay is complete, the time delay is reset and the output relay does not change state. Timing starts again when control input **A1-Y1/B1** re-opens. If control supply voltage is interrupted, the output relay de-energizes and the time delay is reset.

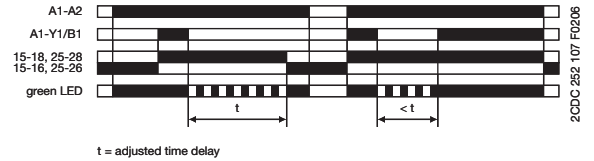

Connection diagram(s)

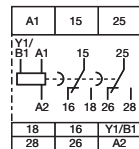

15-16/18
25-26/28
A1-A2
A1-Y1/B1

1. c/o contact
 2. c/o contact
- Rated control supply voltage U_s
24-48 V DC or 24-240 V AC
Control input

Wiring instructions

Parallel load to control input possible / allowed

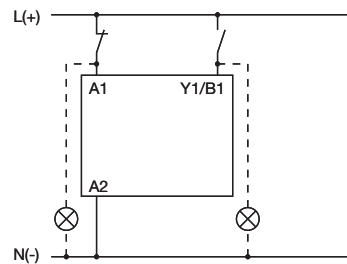



Electronic timer CT-AHD.22

OFF-delayed with 2 c/o contacts

Data sheet

Technical data

Data at $T_a = 25\text{ °C}$ and rated values, if nothing else indicated

Input circuits - Supply circuit		1SVR 500 110 R0100		
Rated control supply voltage U_s	A1-A2	24-240 V AC		
	A1-A2	24-48 V DC		
Rated control supply voltage tolerance	24-240 V AC	-15...+10 %		
	24-48 V DC	-15...+10 %		
Typical current / power consumption		24 V DC	230 V AC	115 V AC
	24-48 V DC	24.12 mA / -	- / -	- / -
	24-240 V AC	- / -	31.30 mA / -	19.89 mA / -
Rated frequency		DC; 50/60 Hz		
Frequency range AC		47-63 Hz		
Power failure buffering time		min. 30 ms		
Input circuits - Control circuit		1SVR 500 110 R0100		
Control input, control function	A1-Y1/B1	start timing external		
Kind of triggering		voltage-related triggering		
Resistance to reverse polarity		yes		
Polarized		yes		
Capable of switching a parallel load		yes		
Maximum cable length to the control inputs		50 m - 100 pF/m		
Minimum control pulse length		30 ms		
Control voltage potential		see rated control supply voltage U_s		
Current consumption of the control input	24 V DC	0.92 mA		
	230 V AC	6.49 mA		
	115 V AC	3.27 mA		
Timing circuit		1SVR 500 110 R0100		
Kind of timer	Single-function timer	OFF-delay with auxiliary voltage		
Time ranges 0.05 s - 100 h		0.05-1 s, 0.5-10 s, 5-100 s, 0.5-10 min, 5-100 min, 0.5-10 h, 5-100 h		
Recovery time		< 50 ms		
Accuracy within the rated control supply voltage tolerance		$\Delta t < 0.005\ %/V$		
Accuracy within the temperature range		$\Delta t < 0.06\ %/^{\circ}C$		
Indication of operational states		1SVR 500 110 R0100		
Control supply voltage / timing	U: green LED	 : control supply voltage applied		
Control supply voltage / timing	U: green LED	 : timing		
Relay status	R: yellow LED	 : output relay energized		
Output circuits		1SVR 500 110 R0100		
Kind of output	15-16/18	Relay, 1. c/o contact		
	25-26/28	Relay, 2. c/o contact		
Contact material		Cd-free		
Rated operational voltage U_e		250 V		
Derating				

Electronic timer CT-AHD.22

OFF-delayed with 2 c/o contacts

Data sheet

Output circuits		1SVR 500 110 R0100
Minimum switching voltage / Minimum switching current		12 V / 100 mA
Maximum switching voltage / Minimum switching current		see load limit curve / see load limit curve
Rated operational current I_o (IEC 60947-5-1)	AC12 (resistive) at 230 V	5 A
	AC15 (inductive) at 230 V	3 A
	DC12 (resistive) at 24 V	5 A
	DC13 (inductive) at 24 V	2 A
Mechanical lifetime		30 x 10 ⁶ switching cycles
Electrical lifetime		0.1 x 10 ⁶ switching cycles (AC12, 230 V, 4 A)
Short-circuit resistance, maximum fuse rating (IEC/EN 60947-5-1)	n/c contact	6 A fast-acting
	n/o contact	10 A fast-acting
General data		1SVR 500 110 R0100
Duty time		100 %
Repeat accuracy (constant parameters)		$\Delta t < \pm 0.5$ %
Dimensions (W x H x D)		17.5 x 80 x 58 mm (0.69 x 3.15 x 2.28 inches)
Weight		approx. 65 g (approx. 0.14 lb)
Mounting position		any
Minimum distance to other units normal operation mode	horizontal	none
	vertical	none
Mounting		DIN rail (EN 60715), snap-on mounting without any tool
Degree of protection	enclosure / terminals	IP50 / IP20
Electrical connection		1SVR 500 110 R0100
all circuits		Screw connection
Wire size	fine-strand with wire end ferrule	2 x 0.5-1.5 mm ² / 1 x 0.5-2.5 mm ² (2 x 20-16 AWG) / (1 x 20-14 AWG)
	fine-strand without wire end ferrule	2 x 0.5-1.5 mm ² / 1 x 0.5-2.5 mm ² (2 x 20-16 AWG) / (1 x 20-14 AWG)
	rigid	2 x 0.5-1.5 mm ² / 1 x 0.5-4 mm ² (2 x 20-16 AWG) / (1 x 20-12 AWG)
Stripping length		7 mm (0.28 inches)
Tightening torque		0.5-0.8 Nm
Environmental data		1SVR 500 110 R0100
Ambient temperature range	operation	-20...+60 °C
	storage	-40...+85 °C
Damp heat, cyclic (IEC/EN 60068-2-30)		6 x 24 h cycles, 55 °C, 95 % RH
Vibration, sinusoidal (IEC/EN 60068-2-6)		4 m/s ² , 20 cycles, 10...150...10 Hz
Shock, half-sine (IEC/EN 60068-2-27)		100 m/s ² , 11 ms
Isolation data		1SVR 500 110 R0100
Rated isolation voltage U_i	Output circuit 1 / Output circuit 2	300 V
	Input circuit / Output circuit	300 V

Electronic timer CT-AHD.22

OFF-delayed with 2 c/o contacts

Data sheet

Isolation data		1SVR 500 110 R0100
Rated impulse withstand voltage U_{imp} (type test) (IEC/EN 60664-1, VDE 0110)	between all isolated circuits	4 kV; 1.2/50 μ s
Power-frequency withstand voltage test (Test voltage, routine test)	between all isolated circuits	2.5 kV, 50 Hz, 1 s
Basic insulation (IEC/EN 61140)	Input circuit / Output circuit	300 V
Protective separation (IEC/EN 61140, VDE 0106 part 101 and part 101/A1)	Input circuit / Output circuit	250 V
Pollution degree (IEC/EN 60664-1, VDE 0110, UL 508)		3
Overvoltage category (IEC/EN 60664-1, VDE 0110, UL 508)		III
Standards / Directives		1SVR 500 110 R0100
Product standard		IEC 61812-1, EN 61812-1 + A11, DIN VDE 0435 part 2021
EMC Directive		2004/108/EC
Low Voltage Directive		2006/95/EC
RoHS Directive		2002/95/EC
Electromagnetic compatibility		1SVR 500 110 R0100
Interference immunity		IEC/EN 61000-6-1 IEC/EN 61000-6-2
electrostatic discharge (ESD)	IEC/EN 61000-4-2	Level 3 (6 kV / 8 kV)
electromagnetic field (HF radiation resistance)	IEC/EN 61000-4-3	Level 3 (10 V/m)
fast transients (Burst)	IEC/EN 61000-4-4	Level 3 (2 kV / 5 kHz)
powerful impulses (Surge)	IEC/EN 61000-4-5	Level 4 (2 kV L-L)
HF line emission	IEC/EN 61000-4-6	Level 3 (10 V)
Interference emission		IEC/EN 61000-6-3 IEC/EN 61000-6-4
electromagnetic field (HF radiation resistance)	IEC/CISPR 22, EN 55022	Class B
HF line emission	IEC/CISPR 22, EN 55022	Class B

Electronic timer CT-AHD.22

OFF-delayed with 2 c/o contacts

Data sheet

Technical diagrams

Load limit curve

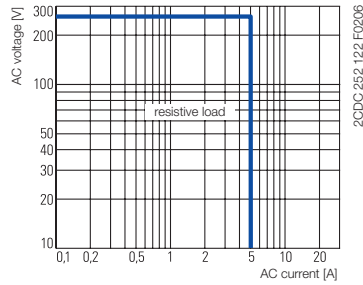

AC load (resistive)

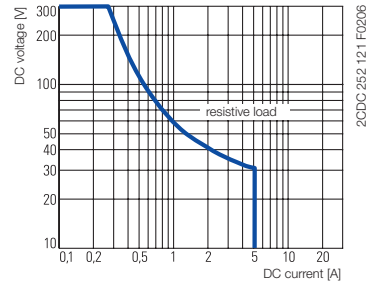

DC load (resistive)

Derating factor F

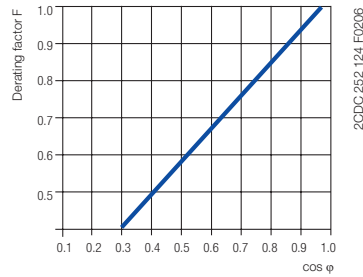

for inductive AC load

Contact lifetime

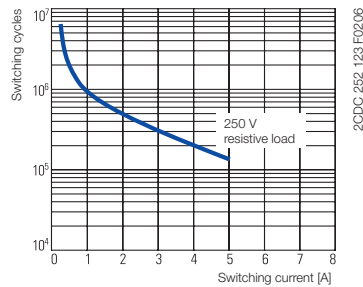

Electronic timer CT-AHD.22

OFF-delayed with 2 c/o contacts

Data sheet

Dimensions

in mm

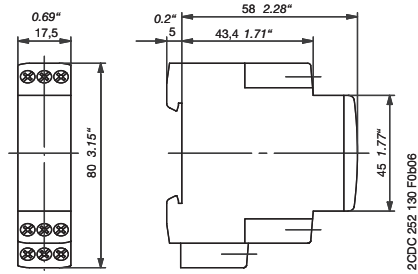

CT-AHD.22

Synonyms

Used expression	Alternative expression(s)	Used expression	Alternative expression(s)
2 c/o contacts	1 DPDT / 2 SPDT	voltage-related	wet / non-floating

Further Documentation

Document title	Document type	Document number
Electronic Products and Relays	Technical catalogue	2CDC 110 004 C020x

You can find the documentation in the internet under www.abb.com/lowvoltage → Control Products → ...



As part of the on-going product improvement, ABB reserves the right to modify the characteristics of the products described in this document. The information given is non-contractual.

For further details please contact (www.abb.com/contacts) the ABB company marketing these products in your country.

Document number: 2CDC 111 054 D0201 (12/2007)

ABB STOTZ-KONTAKT GmbH

Eppelheimer Strasse 82, 69123 Heidelberg, Germany
Postfach 10 16 80, 69006 Heidelberg, Germany
Internet <http://www.abb.com/lowvoltage> → Control Products